





Model Code: LT45DB

Included Accessories

		
ICM6 x 2	6020/OFLOW4 x 2	WK-OF x 2

Optional Accessories

Dimensions

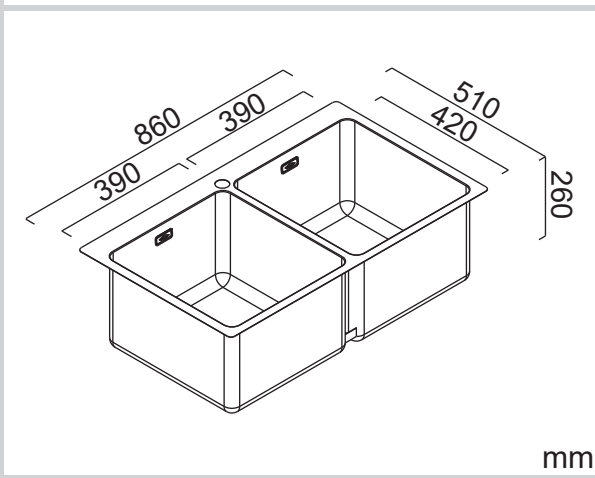

Specifications

Description	Double bowl, Inset sink
Overall Sink Size	860mm x 510mm x 260mm deep
Bowl Dimensions	390mm 420mm x 260mm deep 390mm 420mm x 260mm deep
Drainer Length	N/A
Technic	Handcrafted
Material	Stainless steel SUS304

Installation

Fixings	Inset clips supplied
Template	Supplied
Min Cabinet Size	912mm
Waste Holes	2 x 90mm round Compatible with waste disposal
Sealing Strip	Factory fitted

Plumbing

Waste Fittings	2 x (90mm x 2") basket wastes included
Overflow	Rectangular Overflow

Packaging

Carton Type	Eco packaging & Individual carton
Gross Weight	14Kg
Carton Size	925mm x 355mm x 620mm
Pack QTY	1

SURFACE FINISH



WASTE KIT

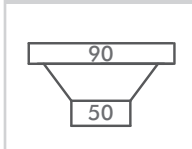

MATERIAL

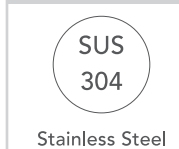

INSTALLATION OPTIONS

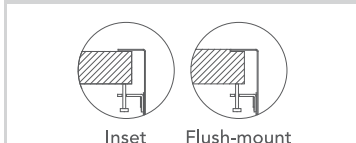

PROFILE

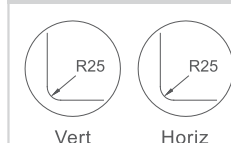

Abey are Australia's leaders in sinkware, designing and manufacturing to the world's highest quality specifications as well as sourcing and bringing you Europe's very best, leading edge designs – practical, affordable, inspirational, stylish, timeless or cutting edge. When you buy an Abey stainless steel sink you receive the highest quality and a 25 year warranty. Abey and the manufacturer are continually seeking ways to improve the design specifications, aesthetic and production techniques of the products. As a result, alterations to the specifications and dimensions of the products and designs occur continually.