



Advantage 450 Grab Rail

Product Image	Product Details
---------------	-----------------



SKU:	428845
Brand:	Argent
Range:	Advantage
Warranty:	5 Years
WELS:	N/A

Additional Features	Technical Specification
---------------------	-------------------------

Required Product

Recommended Products

Additional Notes

- * Clean Seal Flange
- * Manufactured From 304 SS

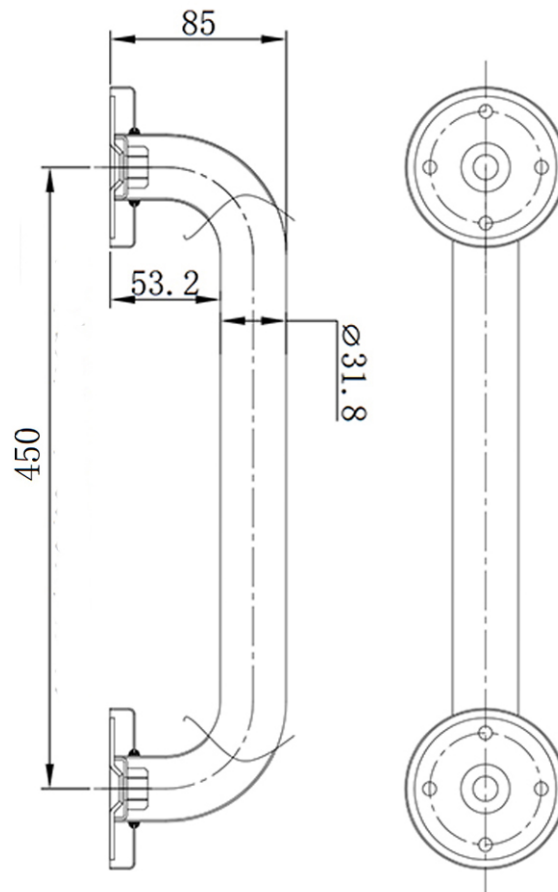

Note: All dimensions are in millimetres and are subject to normal manufacturing variations. Always use the physical product measurements for cut-outs and rough-ins as the technical details shown may differ from the actual product. Use acetic cured silicone sealant. Do not use epoxy type adhesives. Clean with damp cloth. Do not use abrasive cleaners, liquids or pastes.

